

Pro-Line 70

USER MANUAL

EN



Contents

1. Information	3
2. Type Plates	4
3. Overview of Gear Motor.....	5
4. ---	5
6. Printed Circuit Board – Overview.....	6
7. Terminals on Gear Motor.....	7
8. Mains Connection and Motor Connection on PCB	7
9. Low Voltage Connections	8
10. Encoder.....	9
11. Optical Safety Edge and Photo Cell.....	9
12. Traffic Light (Separate Module Needed).....	9
13. Safety Light Curtain	10
14. Programming – Parameter List.....	11
15. Programming – How to Program	12
16. Operation Mode.....	13
17. Reaction while Photo Cell or Safety Edge Activated	13
18. Right / Left turning.....	13
19. Learning Open and Close Limit Position.....	14
20. Fine tuning of electronic Limit	15
21. ½ Open Select.....	16
22. Safety Edge Selection	17
23. After Run	17
24. Wicket Door, Cable Slack Switch (Safety) Circuit	17
25. Carrier Cable Tightening.....	17
26. Photo Cell.....	18
27. Auto Close.....	19
28. Auto Close Function after Activation of Photo Cell (Car Wash Function)	19
29. Forced Closing	19
30. Go Impulse.....	20
31. Interlock.....	20
32. Force Limitation.....	21
33. Run Time.....	22
34. Reverse Time Safety Edge and Photo Cell.....	22
35. Service Counter.....	23
36. Service Counter Reaction.....	23
37. Encoder Position Failure.....	23
38. Special Open or Close Function (Fire Alarm Function)	24
39. Optional Relay K3.....	24
40. Reset to Factory Settings	24
41. Troubleshooting.....	25
42. Technical Data	32
43. Declaration of Conformity	34

1. Information

During installation, it is necessary to observe and follow the safety and accident-prevention regulations valid for the specific application.



CAUTION – Do not connect the CEE plug before installation is complete with all plug-in terminals connected and all screw terminals secured.

In particular, the following standards should be observed (The list may not be exhaustive)

- EN 12453 (Safety in use of power operated doors – Requirements)
- EN 12445 (Safety in use of power operated doors – Test methods)
- EN 12978 (Industrial commercial and garage doors and gates - Safety devices for power operated doors – Requirements and test methods)

It is important to follow this installation guide during installation to insure correct installation. A main switch or CEE plug must be located close to the door control unit and must be easy to reach.

The door must always be correctly balanced.

Only trained personnel should install electrical equipment according to national security regulations.



The product must not be disposed of with regular household waste and must be treated as WEEE (Disposal of electronic equipment).

The original language of the Operating Instructions is English and every other translation is made from this.

During the electrical installation work, the installer should note the following:

- The main power supply must be in the area of a maximum of +/- 10% of the control unit's mains supply.
- Be sure not to overload the gear motor in accordance with the electrical data on the sign on the gear motor.
- Temperature control is necessary when using the control outside the temperature range - 10 -/+ 50°C.
- The control unit must not be used in environments with a risk of condensation.
Furthermore, it is important to mount the control housing on a flat wall without vibrations and away from children and other non-authorized users.



Beware of the clockwise rotating field when using a three-phase motor.

Safety Relays:

In case of a faulty reversing contactor, the three relays RE 1, 2, 3 will disconnect the power to the contactors one second after a stop command if the motor is still running.

SER is shown in the display. Refer to the section Troubleshooting to handle this situation.

Note: The control is locked for electrical operation if the door is moved manually when the control is powered.

Clearing this lock can be done in two ways:

1. Move the door away from the door limits and carry out a new power-up.
2. Turn DIL switch no. 1 ON and OFF again.

2. Type Plates

Gear motor



ConDoor Door Solutions Handelsweg 31 3899 AA Zeewolde				PRO-LINE 70 KU	
U [V]	3 ~ 230/400	n2 [min-1]	14	Production Date	Aug - 2019
f [Hz]	50	Ma [Nm]	450	Cycles / hour	20
I [A]	6,4/3,7	Mn [Nm]	430	Cos ϕ	0,71
P [kW]	1,5	Limit Ratio	20	Amb. Temperature	-5 .. + 40 °C
Protection	IP 54	Duty Rating	S3 = 40% ED	Shaft - \emptyset [mm]	31,25
MADE IN THE NETHERLANDS					



ConDoor Door Solutions Handelsweg 31 3899 AA Zeewolde				PRO-LINE 70 KE	
U [V]	3 ~ 230/400	n2 [min-1]	14	Production Date	Aug - 2019
f [Hz]	50	Ma [Nm]	450	Cycles / hour	20
I [A]	6,4/3,7	Mn [Nm]	430	Cos ϕ	0,71
P [kW]	1,5	Limit Ratio	20	Amb. Temperature	-5 .. + 40 °C
Protection	IP 54	Duty Rating	S3 = 40% ED	Shaft - \emptyset [mm]	31,25
MADE IN THE NETHERLANDS					



Control

DALMATIC TNV A/S - LÆGÅRDSVEJ 9 8520 LYSTRUP - DENMARK			Type: Mini Std. V7E SR		
U	3 ~ 230 / 400 V	Protection	IP 54	 	
f	50 / 60 Hz	Motor Max	2,3 / 4 kW		
I	10 A	Production Date	Aug - 2019		
Motor I max	8,5 A				

Version

PCB: 7-0104 R5018

SOFTWARE: 20.7.19 - 50.03

3. Overview of Gear Motor

Hand Chain

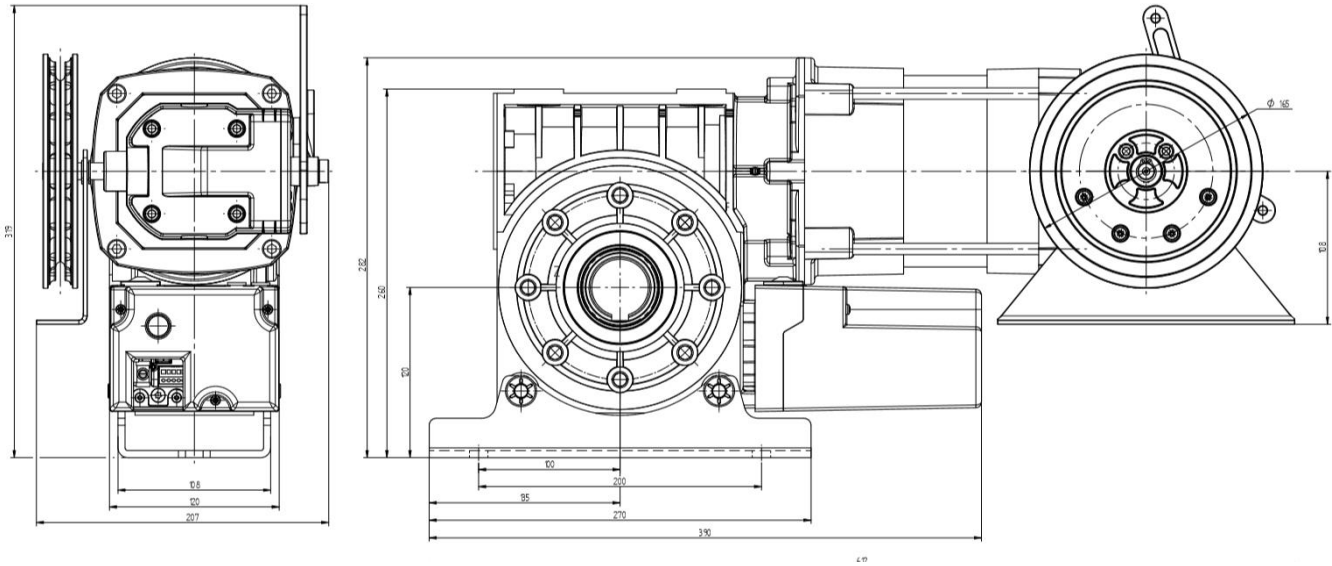

4. --- 5. Emergency Operation

Hand Chain

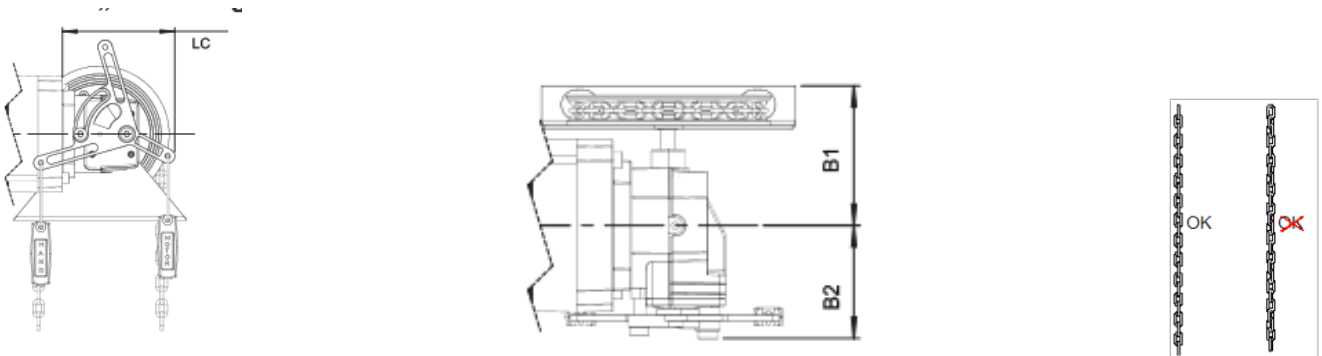

Hand Crank

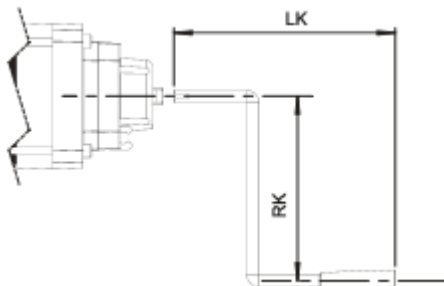

6. Printed Circuit Board – Overview

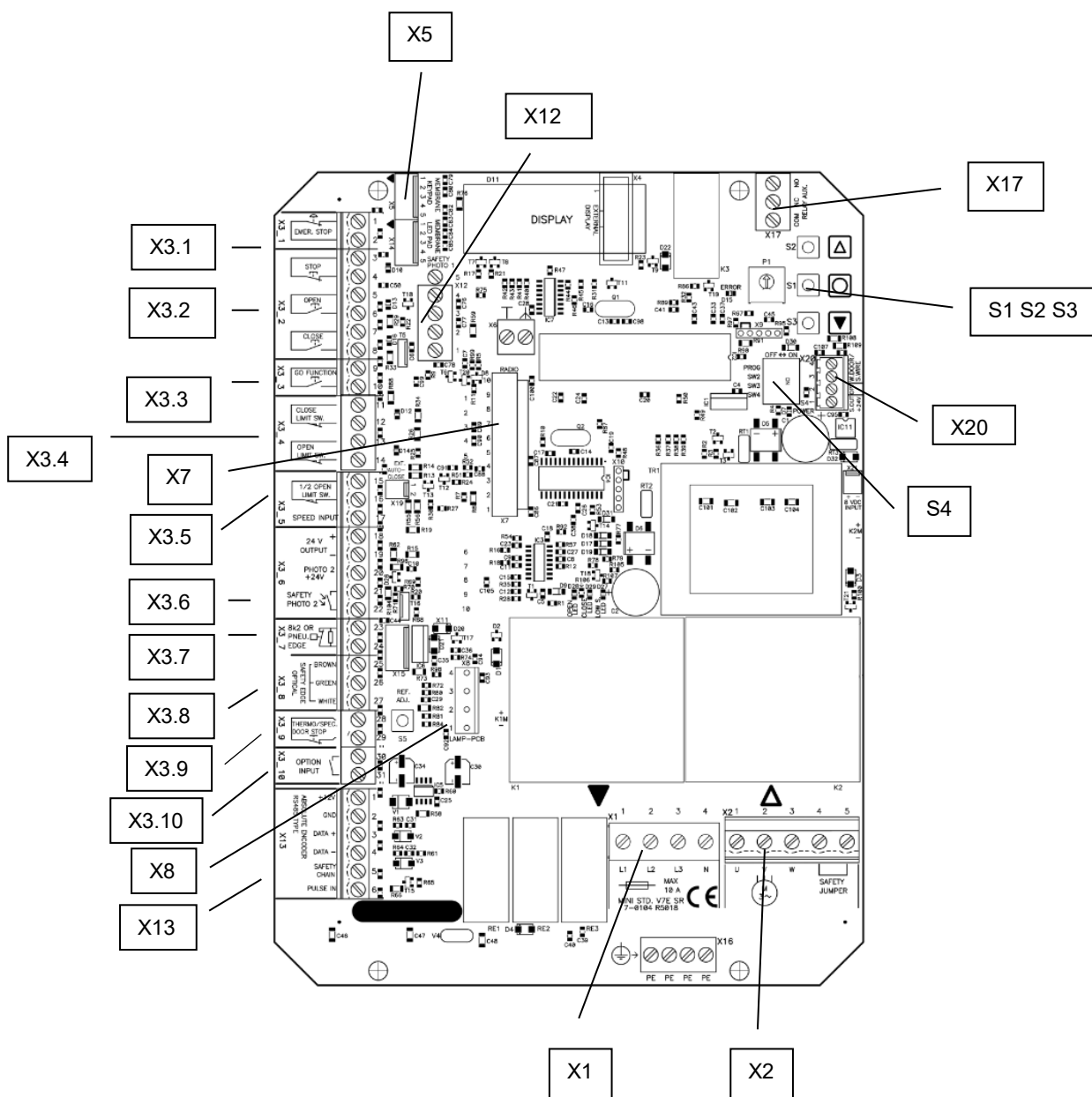

X3.1	Emergency Stop	X1	Power Input
X3.2	Stop – Open – Close	X2	Motor Output
X3.3	Go Function	X5	Push Button Membrane
X3.4	Not Used	X6	Not Used
X3.5	½ Open Switch	X7	Radio Receiver
X3.6	Photo Cell 2	X8	Traffic Light
X3.7	8K2 / Pneum. Switch	X12	Photo Cell 1
X3.8	Opto Safety Edge	X13	Encoder
X3.9	Motor Thermo Switch / Hand Chain Switch	X17	Relay Output
X3.10	Option	X20	Wicket Door / Cable Slack Switch
S1-3	Open – Stop – Close		
S4	Programming Switch		

7. Terminals on Gear Motor

3 x 400V

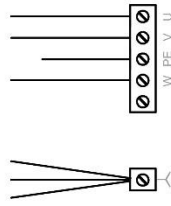

Star

Brown	U
Black	V
PE	PE
Blue	W
Yellow, Red, Green	Star

3 x 230V

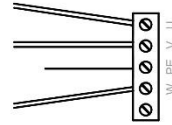

Delta

Brown, Green	U
Black, Red	V
PE	PE
Blue, Yellow	W

8. Mains Connection and Motor Connection on PCB

Mains Connection

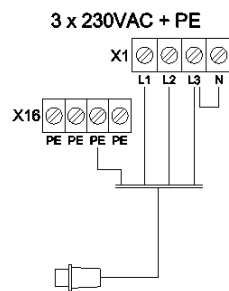
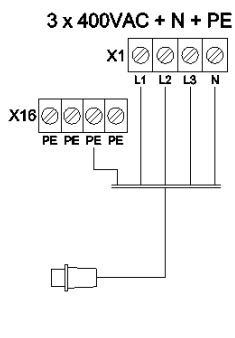

Motor Connection

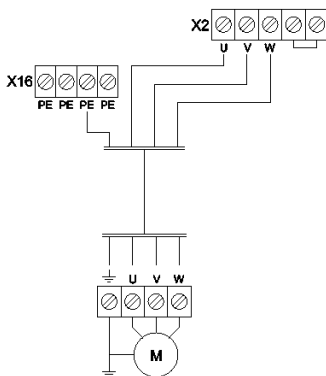

PE must be connected first and disconnected last if motor plug-in terminals are disconnected

9. Low Voltage Connections

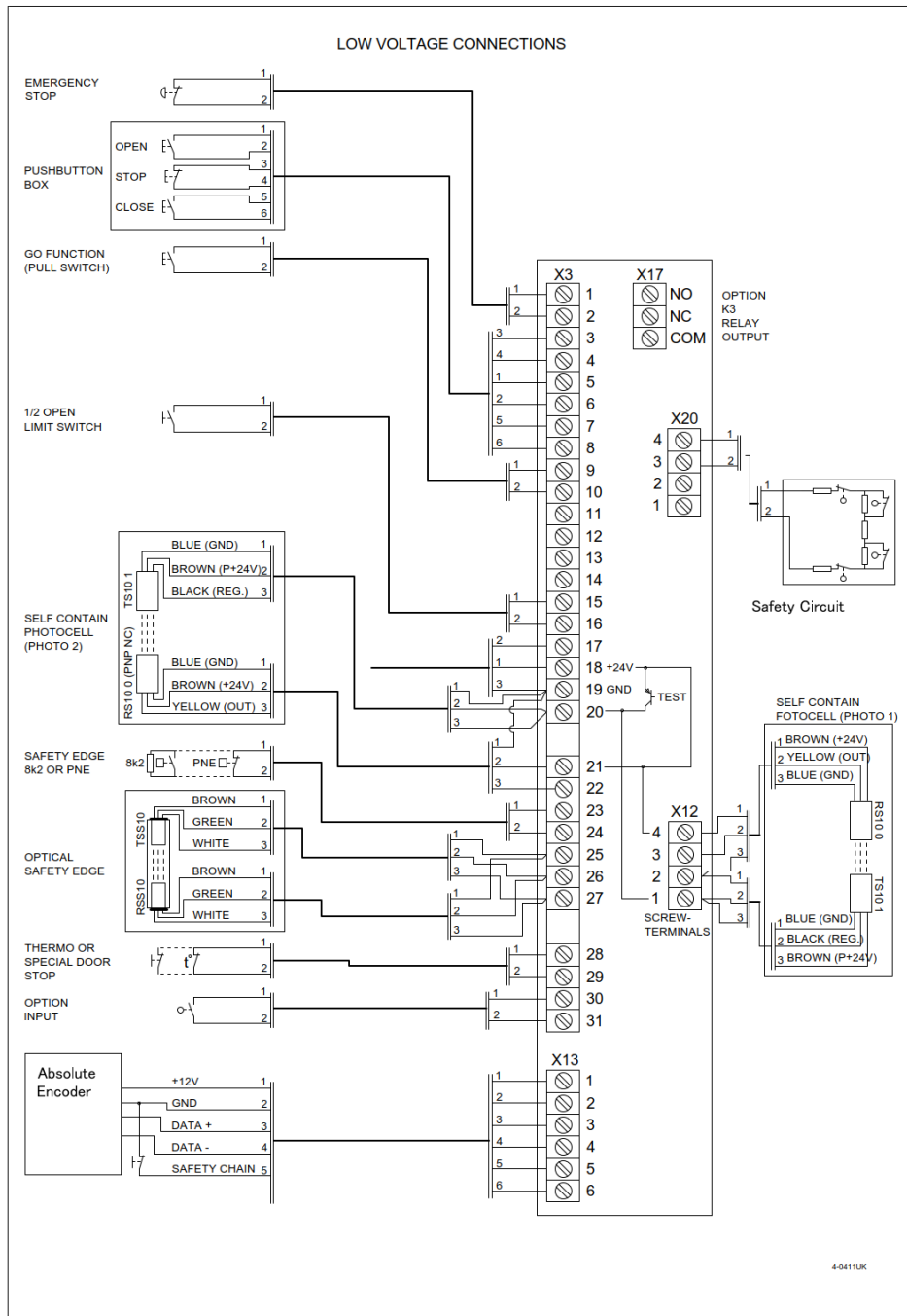

10. Encoder

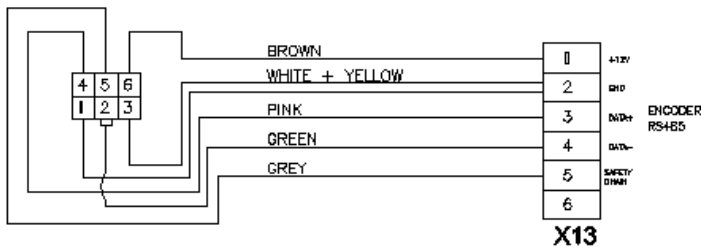

11. Optical Safety Edge and Photo Cell

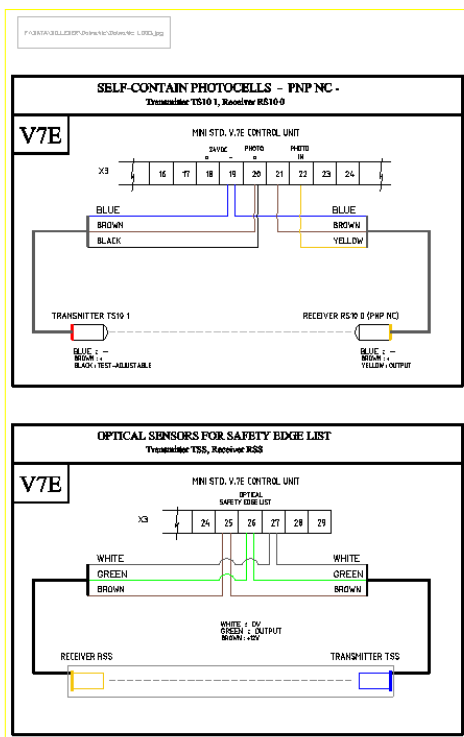

12. Traffic Light (Separate Module Needed)

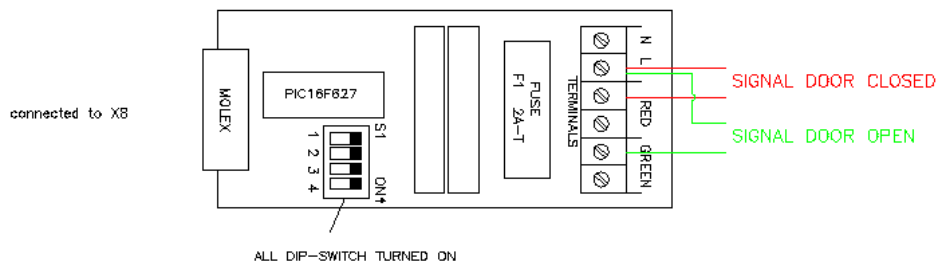

13. Safety Light Curtain

PNP Type Connected to Photo Cell Input

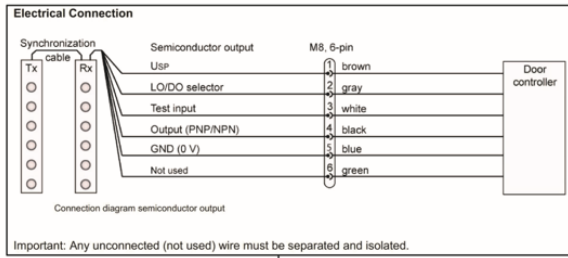

PNP SEMICONDUCTOR TYPE CONNECTED TO PHOTO INPUT

- BROWN 1
- GRAY 2
- WHITE 3
- BLACK 4
- BLUE 5
- GREEN 6

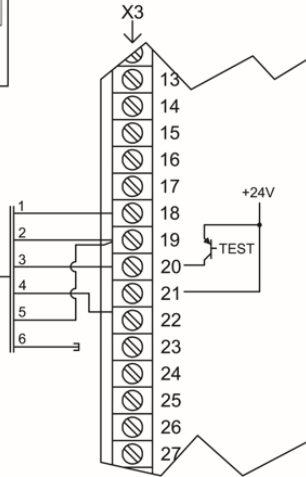

OSE Type Connected to Optical Safety Edge Input

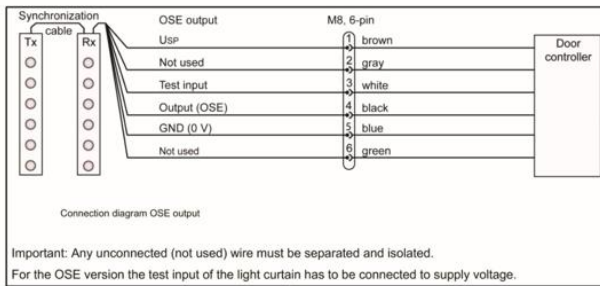

OSE OUTPUT TYPE CONNECTED TO OPTICAL SAFETY EDGE INPUT

- BROWN 1
- GRAY 2
- WHITE 3
- BLACK 4
- BLUE 5
- GREEN 6

FOR USING LIGHT CURTAIN WITH CAR WASH FUNCTION WITH THIS OSE INPUT - SELECT EDGE TYPE 21:06.

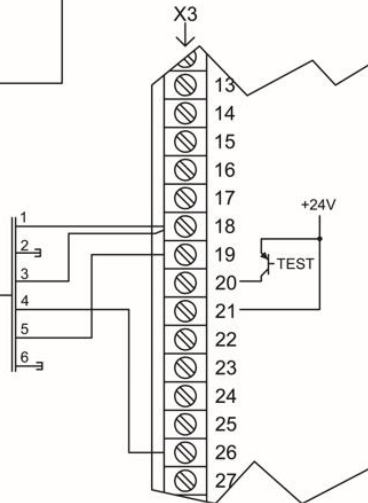

14. Programming – Parameter List

01:01	Operation mode
02:01	Reaction while photo cell or safety edge activated
11:05	Right turning
12:┌ ┐	Electronic limit settings, OPEN
14:└ ┘	Electronic limit settings, CLOSE
13:	Fine tuning of electronic Limit OPEN
15:	Fine tuning of electronic Limit Close
16:00	1/2 open settings
17:00	Auto close 1/2 open
21:03	Safety edge selection
22:00	Electronic after run
23:05	Wicket door, cable slack switch
29:00	Cable tightening
31:00	Photo cells
32:00	Auto close
33:00	Auto close after activation of photo cell (car
34:00	wash) Forced closing
35:00	GO impulse
36:01	Interlock
41:00	Force limitation
44:02	Force limitation automatic
51:02	Run time
52:01	Reverse time safety edge
53:30	Reverse time photo cells
58:00	Service counter
59:00	Service counter reaction
81:03	Encoder position failure
84:00	Special open or close function
88:00	Option relay K3 settings

15. Programming – How to Program



The door will always run in hold-to-run mode (deadman operation) in programming mode

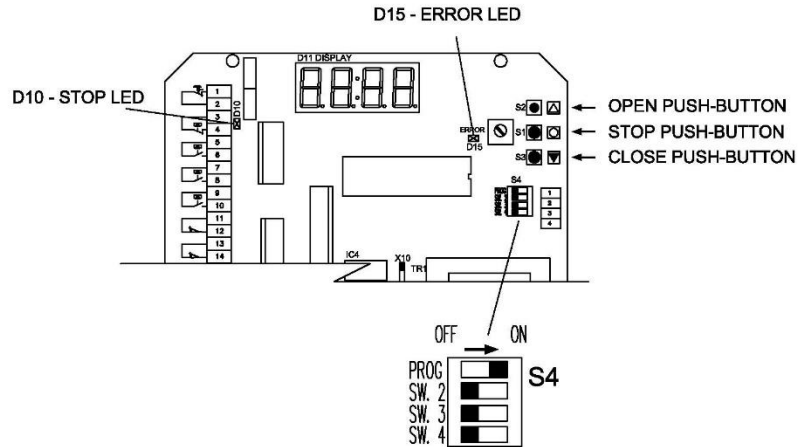

Program the control by opening the enclosure. Find OPEN - CLOSE - STOP push-buttons and a 4 pole DIL switch on the PCB (S4).



CAUTION! Be sure that stop circuits are mounted and no emergency stop or other stop circuit is activated before entering programming mode. LED D10 must not light up. See description of stop circuits in section 1, Connections.

1. Select programming mode:
To enter programming mode change DIL switch S4 to ON position. The door will always run in hold-to-run mode when programming.
Back to normal mode: Change DIL switch 1 to OFF position.
2. Navigating the table:
STOP push-button is used to navigate between parameter number and parameter value.
OPEN and CLOSE push-buttons are used to select parameter number or change parameter value.
Active digits will be flashing. Some of the parameters have an extra step when pressing the stop push-button. For example, when the door needs to run in programming mode. Display will show "RUN".
3. Parameter explanation

01:01

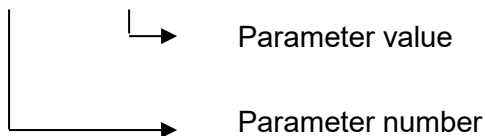



Shaded values show factory settings **00:00**

16. Operation Mode

01:01

Hold-to-run OPEN

Hold-to-run CLOSE.

Put a bridge in X3 terminal 23-24 when there is no safety device connected.

01:02

Impulse OPEN

Hold-to-run CLOSE.

Put a bridge in X3 terminal 23-24 when there is no safety device connected.

01:03

Impulse OPEN

Impulse CLOSE

01:04

Impulse OPEN

Impulse CLOSE

0.5 sec reverse by stop on force control in opening direction.

17. Reaction while Photo Cell or Safety Edge Activated

02:00

Hold-to-run operation not possible when failure in photo cell or safety edge.

The door cannot close when there is an error in photo cell or safety edge. With a special code, the door can close one time in hold-to-run mode.

Press and hold STOP when pressing 222111

2 = DOWN push-button

1 = UP push-button

02:01

Hold-to-run operation possible when failure of photo cell or safety edge.



Do not use 01 when a device with a constant close signal is mounted.
Usage of 01 is at customer's own risk.

18. Right / Left turning

11:05

Right turning

11:06

Left turning

19. Learning Open and Close Limit Position

Open Limit



Error LED D15 flashes 2 times until both limits are learned.

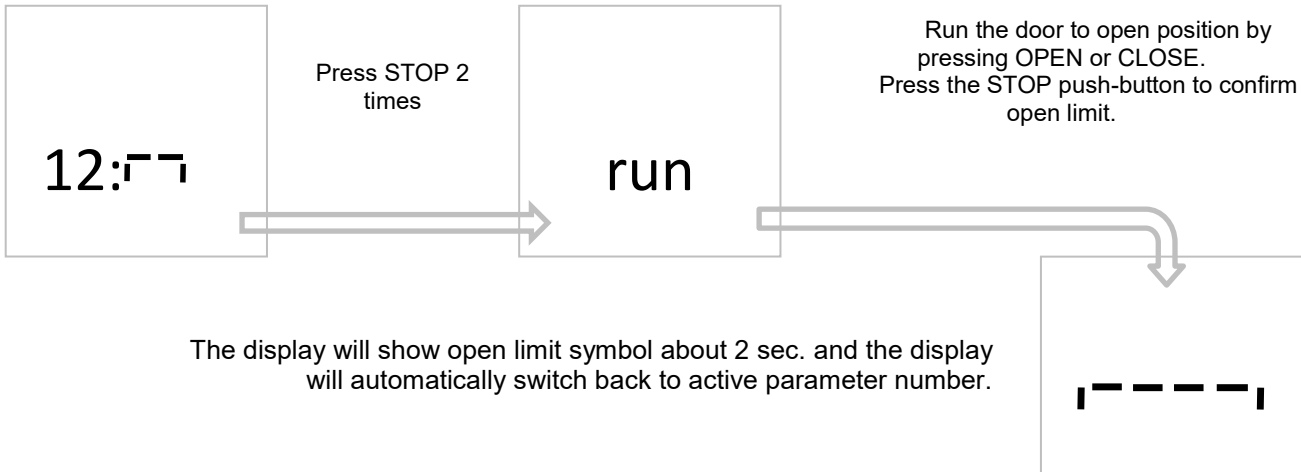

½ OPEN limit cannot be active during programming (parameter 16).

Photo cell in the door frame (parameter 31) cannot be active during learning of limits.

When relearning limits, parameter 41 (force limitation) and 51 (run time) will be reset to factory setting.

CLOSE LIMIT

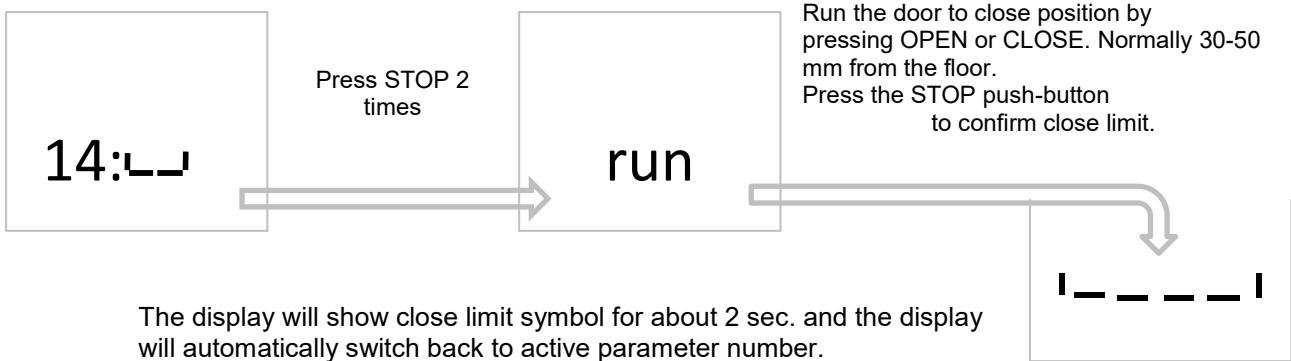

ERROR LED D15 will now stop flashing.

If it flashes 4 times, the wrong encoder rotation in parameter 11 has been set. Change settings in parameter and start learning limits right from the beginning.

20. Fine tuning of electronic Limit

Fine tuning of electronic Limit OPEN

13:  5

Press STOP push-button until the display parameter value is active.

Fine tune OPEN limit 6-9 more open, 1-4 less open. Press OPEN or CLOSE push-button to change value.

Run

If the value is changed: Press STOP push-button
Display shows "RUN".

Test the fine tuning by running the door up and down.

Press the STOP push-button to save and return to parameter value.

Adjustment range is maximum +/- 0.8% of the door run range.

Pressing STOP without a value change = return to parameter number.

Fine tuning of electronic Limit CLOSE

15:  5

Press STOP push-button until the display parameter value is active.

Fine tune CLOSE limit 6-9 more open, 1-4 less open. Press OPEN or CLOSE push-button to change value.

Run

If the value is changed: Press STOP push-button
Display shows "RUN"

Test if the fine tuning by running the door up and down.

Press the STOP push-button to save and return to parameter Value.

Adjustment range is maximum +/- 0.8% of the door run range.

Pressing STOP without a value change = return to parameter number.

21. ½ Open Select

16:00 No ½ open active.

ON/OFF controlled by switch in connector X3, 15+16

16:02	½ open stop active. Electronic limit on 5 % open position.
16:03	½ open stop active. Electronic limit on 10 % open position.
16:04	½ open stop active. Electronic limit on 20 % open position.
16:05	½ open stop active. Electronic limit on 40 % open position.
16:06	½ open stop active. Electronic limit on 60 % open position.
16:07	½ open stop active. Electronic limit on 80 % open position.
16:08	½ open stop active. Electronic limit on 90 % open position.
16:09	½ open stop active. Electronic limit on 95 % open position.

½ OPEN command by a push-button NC in connector X3, 15+16

16:10	½ open stop active. Electronic limit on 5 % open position.
16:11	½ open stop active. Electronic limit on 10 % open position.
16:12	½ open stop active. Electronic limit on 20 % open position.
16:13	½ open stop active. Electronic limit on 40 % open position.
16:14	½ open stop active. Electronic limit on 60 % open position.
16:15	½ open stop active. Electronic limit on 80 % open position.
16:16	½ open stop active. Electronic limit on 90 % open position.
16:17	½ open stop active. Electronic limit on 95 % open position.

Auto close from ½ open

17:00	No auto close from ½ open limit.
17:01	Auto close from ½ open limit.

Auto close must be activated in parameter 32.

22. Safety Edge Selection

21:01	PNE / DW pressure wave switch
21:02	8k2 ohm electrical
21:03	Optical
21:05	Wireless edge with test function on X20
21:06	Light curtain with OSE output. For connections, see section entitled Light Curtain.

The actual edge must be connected but not activated before this setup.
If the controller has made a wrong closing edge selection, the display will show ERR.

Nothing must be connected to X3 terminal 23-24 when parameter value 03 or 06 has been chosen.

23. After Run

Used to prevent the door from reversing when it reaches the floor before the close limit is activated – for instance if there is dirt in the door opening or if the carrier cables are getting longer.

22:00	No after run Value 00 = NO monitoring of PNE/DW *
22>00	After run active – after run time 0.01 – 0.50 sec.

*Monitoring of PNE/DW air switch safety edge is automatically selected when after run is active
When the door reaches the close limit position when closing the door, it will continue to close until the PNE/DW pressure wave switch activates or until the after run time is exceeded.

Set close limit about 30-50 mm over the floor. Adjust the door to the floor by setting the after run time to the right level until the door stops on PNE/DW signal from the safety edge.

24. Wicket Door, Cable Slack Switch (Safety) Circuit

23:04	Wicket door/cable slack switch (with evaluation of resistance)
23:05	Wicket door/cable slack switch (as NC circuit)

25. Carrier Cable Tightening

Used to prevent the carrier cable from loosening when the door is closed. Works as a small pull back time when the door stops at the close limit.

29:00	No carrier cable tightening function
29:01	Carrier cable tightening 5 ms
29:02	Carrier cable tightening 10 ms
29:03	Carrier cable tightening 20 ms
29:04	Carrier cable tightening 30 ms

26. Photo Cell

Photo cell 1: External photo cell mounted in screw terminals X12

Photo cell 2: External photo cell mounted in screw terminals X3

31:00	No photo cell safety device connected
31:01	Photo cell 1 connected
31:02	Photo cell 2 connected
31:03	Photo cells 1 and 2 connected

Additional photo cell mounted in the door frame.

After selecting the right parameter value, run mode is available by pressing stop. Location of photo cell will now be learned by running from close to open position. The door will stop when the photo cell is no longer blocked and the control unit will change back to the parameter number automatically.

31:04	Photo cell 1 connected and mounted in the door frame.
31:05	Photo cell 2 connected and mounted in the door frame.
31:06	Photo cells 1 and 2 connected and photo cell 1 mounted in the door frame.
31:07	Photo cells 1 and 2 connected and photo cell 2 mounted in the door frame.

Install additional safety photo cells in the door frame to protect the photo cells from the sun and damage. After installation, the photo cells will automatically be disabled when the door passes the photo beam.

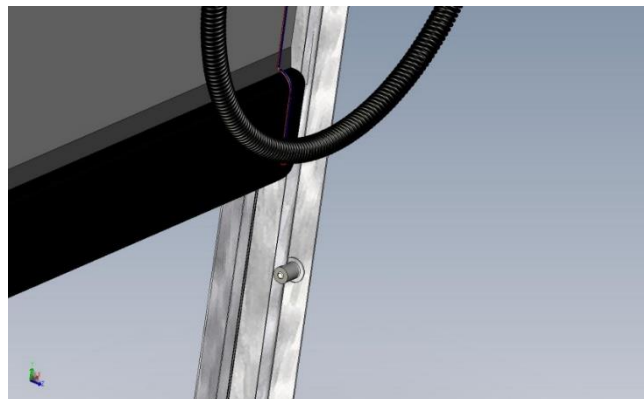

27. Auto Close

Set the door to auto close after a selected time. Auto close can be switched ON/OFF with a jumper in X19.

32:00

No auto closing

32>00

Seconds 1 – 990. After 99, it will change in x10 of seconds and the value will flash quickly - e.g. 18 is 180 seconds.

Countdown of auto close time will show in the display.

The impulse close must be selected in parameter 1.

Interlock:

If stop or emergency stop is activated for more than 5 sec. with the door in open position. The auto close is interlocked to prevent closing. Reset of interlock by CLOSE push-button or "Go Function" CLOSE. If the interlock function is not wanted, deselect this in parameter 36.



WARNING

Automatic closing is normally only allowed if additional photo cell safety is used and selected in parameter 31.

28. Auto Close Function after Activation of Photo Cell (Car Wash Function)

Countdown of auto closing time starts, only if photo cell has been activated for more than "photo cell active time". Door must be completely closed before the start of a new cycle.

33:00

No function

33>00

Photo cell active time in 0.1 sec. units (e. g. 15 = 1.5 sec.)
(Adjustable 1 – 30 units – 0.1 sec. to 3.0 sec.)

29. Forced Closing

Only when function is selected in parameter 33.

34:00

No forced closing

34:01

Forced closing after 2 min. (even if photo cell has not been activated).

34:02

Forced closing after 5 min. (even if photo cell has not been activated).

34:03

Forced closing after 10 min. (even if photo cell has not been activated).

34:04

Forced closing after 20 min. (even if photo cell has not been activated).

30. Go Impulse

Impulse function used for open – stop - close operation.



It is only possible to close the door with the Go function when a safety photo cell is used and is selected in parameter 31.
For auto close without additional safety photo cell, connect a bridge in X3: 20-22 and select parameter 31:02 (at customer's own risk).

35:00

Go function (closing is only possible from open limit)

35:01

Go function: open – stop – close – open – stop – close etc.

35:02

Go function with open function only.

35:03

Go function: open – stop – close – stop – open – stop etc.

Parameters only visible if a photo cell is selected in parameter 31.

31. Interlock

36:00

Interlock function OFF.

36:01

Interlock function ON.

Parameters only visible if auto close option is selected in parameter 32.

32. Force Limitation

All mechanical spring and door limits must be adjusted before selecting force control.

Force limitation is an added safety to prevent an obstacle from being lifted by the door in the opening direction and, in the closing direction, the force limitation acts as extra safety on the closing edge. The balance of the springs is monitored with the force limitation with a tolerance selected in parameter 44.

Force limitation settings

41:00	No force limitation
41:03	Not in use
41:04	Force limitation by automatic learning

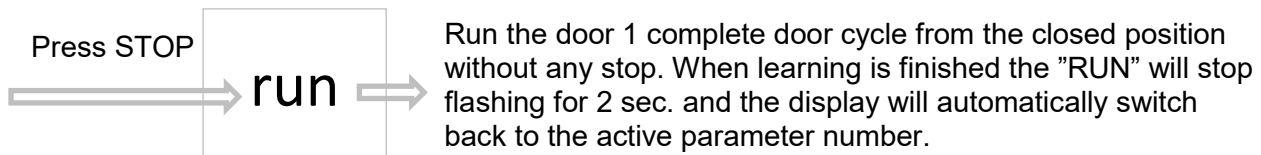

If new automatic learning is wanted, press stop 2 times until "RUN" is flashing again.
(For setup of torque – refer to parameter 44).

Note 1: Minimum door opening time is 7.0 sec.

Note 2: The encoder rotating angle used is important. A more than 180-degree angle is recommended.

The door opening time is also important and ought to be between 7 and 14 sec.

If the door opening time is between 14 and 25 sec., the encoder rotating angle used must be between 270-310 degrees.

Longer door opening times need more than 360 degrees. Kostal encoders cannot be used at more than 310 degrees.

Shorter door opening times of less than 7 sec are not recommended because of non-accurate door limits.

Sensitivity force limitation automatic learning, parameter 41:04

44:02	Force limitation delay	0.4 sec.
	Stopped at low speed	-3.5 %
	Force limit from initial values	-7.0 %
44:05	Force limitation delay	0.4 sec.
	Stopped at low speed	-7.0 %
	Force limitation from initial values	-14.0 %

Automatic force adjustment door balance	0.9 %/10 door cycles
Reaction time for force change	about 2.4 sec.

33. Run Time

The door will stop if the pre-set run time is exceeded and the display shows E:03.

Run time control

51:00	No run time control
51:01	Run time 20 sec.
51:02	Run time 40 sec.
51:04	Run time 60 sec.

Run time control - automatic learning

51:03	Automatic run time. "RUN" position is now available by pressing STOP. Run the door from closed to open position without any stop. Keep pressing OPEN.
--------------	--

When run time is learned by open limit, "RUN" will stop flashing and the display will automatically switch back to active parameter number. Run time equals learning time + 12.5%. Below 10 seconds learning time, a fixed time of 1 second is added.

Both limits must be set before selecting automatic run time.

34. Reverse Time Safety Edge and Photo Cell

Safety edge

52:01	Reverse time of safety edge in 1/100 seconds. 0.00 – 0.99 sec. Example: 01 = 0.01 sec. If 00 is selected, the reverse time is set to a minimum of 0.004 sec.
--------------	--

Photo cell

53:30	Reverse time of photo cell in 1/100 seconds. 0.05 – 0.99 sec. Example: 30 = 0.30 sec. This reverse time is also used as force reversing time.
--------------	---

35. Service Counter

Use the service counter to define the service interval on doors.

Service counter setup

58:00	No service countdown
58:01	15 open cycles before service (for testing only)
58:02	5000 open cycles before service
58:03	10000 open cycles before service
58:04	20000 open cycles before service

Reset for new countdown or selection value:

Press STOP to select parameter value. Press OPEN or CLOSE to select value.

Press STOP again for a minimum of 2 sec. CLR is shown for 2 sec. in display to confirm new countdown.

36. Service Counter Reaction

59:00	Display shows E:04
59:01	After switching to hold-to-run control (deadman operation) display shows E:04

The service LED will light up when the service countdown reaches 0.

37. Encoder Position Failure

Delay time indication of missing encoder position

81:00	1 sec
81:01	2 sec
81:02	4 sec

Display shows E:09 after pre-set operation time without change of encoder position. Failure can be reset by hold-to-run to find both end limits or for relearning of limits.

Encoder position failure – automatic resetting

81:03	4 sec after operation without change of encoder position, the door will stop and error code E:09 will be automatically reset.
-------	---



No limit monitoring by selecting value 03

38. Special Open or Close Function (Fire Alarm Function)

84:00

Normal open function

84:01

Special open function: Open signal with high priority.

The door will always open on a continuously open signal, even after a stop command.
E.g. a FIRE open signal.

84:02

Special close function: Close signal with high priority.

The door will always close on a continuously close signal, even after a stop command.
E.g. a FIRE close signal.

39. Optional Relay K3

Mechanical relay and terminals X17 need to be mounted on the PCB on position K3.

88:00

K3 active when door is running

88:01

K3 active when the door is closed

88:02

K3 active when the door is open

88:03

K3 used for electric lock

40. Reset to Factory Settings

Reset to factory settings by changing DIL switch 4 (S4) to ON position and activating STOP and UP push-buttons within 2 seconds.

The display will flash with "FAC" and the program version number will be shown.

After this, switch DIL switch 4 back to OFF position.

41. Troubleshooting

LED – Codes: LED on Printed Circuit Board

4-digit LED display:
See run mode and error symbols.
Page 28 – 31.

LED D15:
Flashing 1-9 times.
Page 27.

LED D10:
NC circuits active.
Check emergency stop (X3:1-2)
or stop (X3:3-4), stop (X3:28-29), safety jumper
(X2:4-5)
or switch/thermal overload protection in gear motor
(X13:2-5)
or an internal stop, check flash code on Error LED-
D15

LED D13

LED D16

LED D12

LED D14

LED D28

LED D29

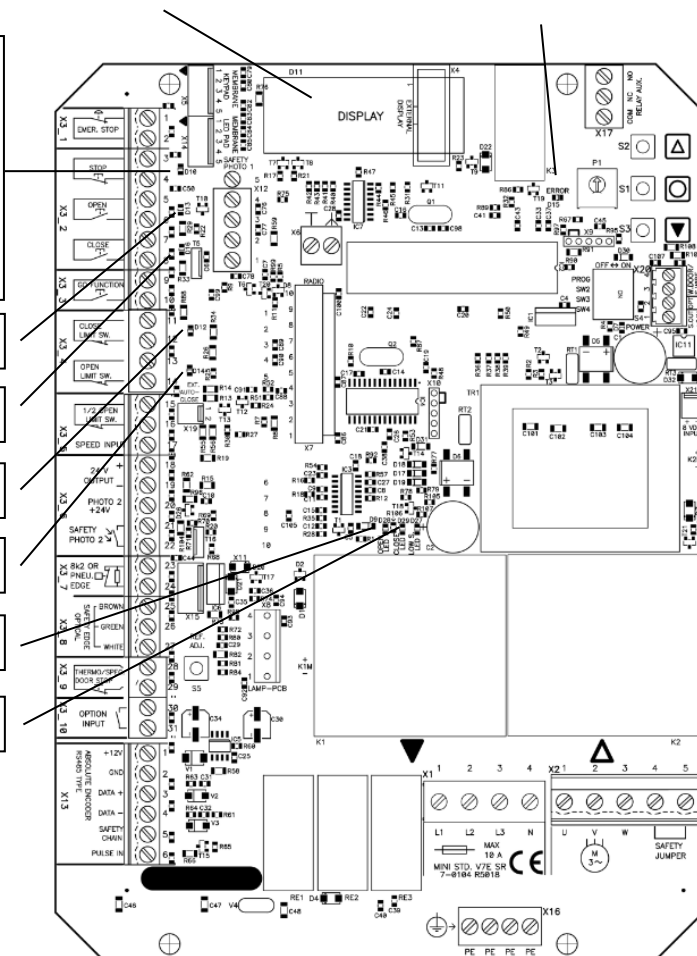

LED	Explanation
D15	Error LED – shows error codes (see page 28)
D10	Stop active (X3:1-2, X3:3-4, X3:28-29, X13:2-5, X2:4-5) LED is also active in fail mode. Observe display and D15 ERROR LED
D13	Open active
D16	Close active
D12	Close Limit active
D14	Open Limit active
D27	Not used
D28	Power ON to Open contactor
D29	Power ON to Close contactor

LED – Codes: LED on Push-Button Membrane in Lid



LED	Explanation
Constant light	Stop activated or wicket door/slack rope contact
Quick flash	Photo cell or safety edge active, when CLOSE push-button is active
1 flash	E:01 Error in safety edge
2 flashes	E:02 Force limitation
3 flashes	E:03 Run time
4 flashes	E:04 Service counter reached 0
8 flashes	E:08 Force monitoring
9 flashes	E:09 No change of encoder position

Error Codes











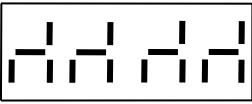

Error Codes - D15 Error LED on PCB



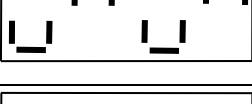





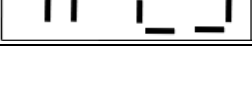

Flashes on error LED	Explanation	To solve error
1	No answer from encoder (no 24VDC control voltage)	<ul style="list-style-type: none"> - Check connections - Check the 24VDC voltage at terminal X3 18-19
2	Limits not learned	Learn limits
3	Motor running unintended	Service needed. Fatal error. Move the door manually away from door position limits and carry out a new power-up. Alternatively: Move the door manually to middle position. Change from normal mode to programming mode on DIL switch no. 1. This will clear the SER error. If the door is running again within 1 sec. without a command when the power is on, then the PCB is faulty.
4	Calculation error	Check that parameter 11 value is correctly selected. (Select anti-clockwise/clockwise rotation). Possible user error – both limits are the same. Encoder error.
5	Not in use	
6	Not in use	
7	Encoder – wrong selection of anti-clockwise/clockwise rotation	Check that parameter 11 value is correctly selected. (Select anti-clockwise/clockwise rotation) or re-learn limits
8	Encoder –Operating voltage failure	Check connection and supply voltage. Change encoder
9	EEPROM failure on IC4 by power up	<ul style="list-style-type: none"> - Re-learn limits and - carry out a new power-up in that order or - perform a factory reset and - a new power-up in that order

Display in Run Mode

In run mode the display will show status of limits, some inputs or error codes if they occur.

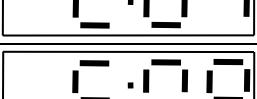
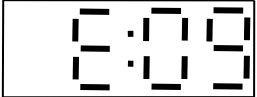
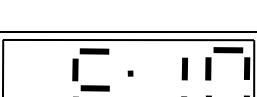
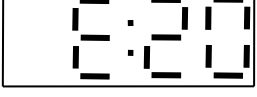
When powering up, the software version is showed briefly.

Parameter	Description
	Nothing active Nothing active. Door is stopped between limits and no errors are found.
	Open limit active
	Close limit active
	1/2 open limit active
	STOP active
	OPEN push-button active Activation of loop detector will also show this symbol
	CLOSE push-button active
	GO function active The door only can be closed by GO function when photo cell is installed
	Photo cell 1 active Photo cell 2 is external photo cells mounted in the screw terminals X12.
	Photo cell 2 active Photo cell 2 is external photo cells mounted in the screw terminals X3
	Safety edge active
	Safety edge not mounted correctly/wrong selection in parameter 21
	Door running up
	Door running down
	X20 active

	<p>Error code: Door is running without command Service needed. Fatal error. Move the door manually away from door travel limits and carry out a new power up. Alternatively, change from normal mode to programming mode on DIL switch no. 1. This will also clear the SER error. If the door is running again in 1 sec. without command when power is on, then the PCB is defective.</p>
	<p>Error code: Edge monitoring Error code Monitoring failure of safety edge if this function is activated. Check or adjust safety edge list. See parameter 21.</p>
	<p>Error code: Force limitation Door is stopped by force limitation when this function is active. Symbol also shown if the automatic force limitation is not learned, when returning to run mode. Re-learn force limitation or change sensitivity in parameter 44</p>
	<p>Error code: Run time Door is stopped on run time control. See parameter 51.</p>
	<p>Error code: Service Service counter decremented to 0 Reset for new countdown</p>
	<p>Error code: Photo cell Failure in photo cell circuit. Test cycle after last stop failed. Press stop to start new test</p>
	<p>Error code: Safety edge Failure in edge circuit. Test cycle after last stop failed. Press stop to start new test</p>
	<p>Not applicable</p>
	<p>Error code: Speed monitoring Speed too low. Check if the door is in good condition mechanically and relearn force limitation.</p>
	<p>Error code: No change of encoder position when running. Door started, but the position is not changing. Door is stopped after delay time and E:09 failure is shown about 1 sec. Possible errors: The door is blocked, disengaged, or cable connection error. Reset of E09: both limits shall be found again by hold-to-run encoder positioning. (If it is not possible to find both limits, the limits must be relearned) If necessary, adjust in parameter 81 (delay time) (Parameter 81:03 = autoreset)</p>
	<p>Error code: Second safety edge or wicket door (X20-3,4) Failure in edge circuit. Test cycle after last stop failed. Press stop to start new test</p>
	<p>Error code: EEPROM fail Limits have been changed after the force limitation was learned. Reset of E20: Deactivate force limitation in parameter 41 (41:00) and, after this, carry out a new power-up.</p>
	<p>Error code: EEPROM fail EEPROM failure of power-up. Factory reset or change PCB.</p>

12V

and

12V

and



24V

Error in 24V and/or 12V voltage circuit.
24/12V is shorted or overloaded.

Electronic Counter and Last 10 Errors

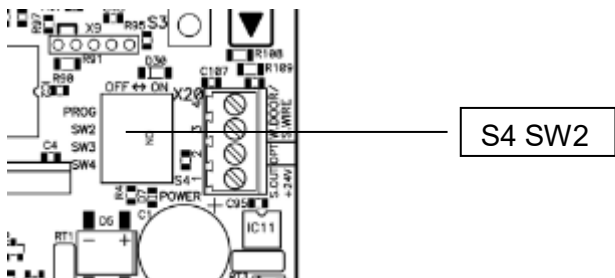
Close the door and turn switch S4 SW2 to ON.
 The door cannot be moved when display status is active.

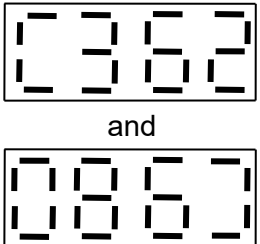
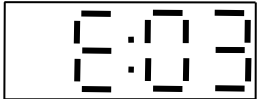

Parameter	Description
<p>Electronic counter status</p> 	<p>The display flashes between the most significant digits (1000 to 999000) and the least significant digits (000 – 999).</p> <p>Example shown is (362 and 086) = 362086 door openings</p> <p>Press STOP to see last 10 errors or exit by switching DIL switch 2 to OFF.</p>
<p>Last 10 errors</p> 	<p>Press OPEN to select newer error Press CLOSE to select older error</p> <p>If there are no errors, the display will show:</p>  <p>At the end of the 10 errors registered, the display will show:</p>  <p>Upper end Lower end</p> <p>Switch DIL switch 2 to OFF to exit "display status". Reset of last 10 errors by pressing OPEN for at least 10 sec. when "upper end" symbol is shown</p> <p>Exit by switching DIL switch 2 to OFF.</p>

42. Technical Data

Installation	Vertical on a vibration-free and flat wall
Temperature range (operating)	-10...+50°C
Humidity	Up to 93% RH, non-condensing.
Vibration	Low-vibration installation, wall mounted.
Enclosure data	IP54 293 x 190 x 100 mm, ABS
PCB dimension	163 x 225 x 80 mm
Supply voltage	400VAC ± 10% L1, L2, L3, N, PE or 230VAC ± 10% L1, L2, L3, PE. 50/60Hz, Mains fuse max: 3 x 10A Rated insulation voltage $U_i = 400V$
Transformer	Max 13 VA VDE 0570/EN61558 Primary 230VAC winding is thermal protected by built-in thermal transformer fuse. Both secondary windings are overload protected with multifuses.
Motor output	Max motor load at 3 x 400VAC: 4 kW Max motor load at 3 x 230VAC: 2.3 kW Max motor current: 8.5A
Emergency stop, Stop, Thermo spec. door stop and Safety chain	Function as normal stop command and disconnect power to contactor coils.
24VDC Output: Terminals X3-18, X3-19	24VDC ± 20% (non-regulated), Max load: 250mA ($T_{amb} = 25\text{ °C}$) Max load: 200mA ($T_{amb} = 40\text{ °C}$)
Input Safety edge	Type PNE/air switch Type - 8k2 termination ± 10% Type OSE Witt Performance level C, Category 2

Optical safety edge	Input voltage high (green): 2.5 - 5.0 Volt. Input voltage low (green): < 0.5 Volt. Input frequency range (green): 250 – 2000 Hz. @ 50% duty cycle Pulse interval maximum (green): 7.0 ms when not 50% duty cycle
Photo cell input	X12-1,2,3,4 External photo cell, 24 VDC X3-19,20,21,22 External photo cell, 24VDC Performance level C, Category 2
Electronic limits	RS485, Data+ Data-, terminated with 120 Ohm
Option relay output (K3 + X17)	Change over contact: 230VAC/5A
Directives – EMC Directive 2014/30/EU	EN 61000-6-3 (2007) + A1:2011 Emission – Residential EN 61000-6-1 (2007) Immunity – Residential EN 61000-6-4 (2007) Emission – Industry EN 61000-6-2 (2005) Immunity – Industry EN 61000-4-3 (2006) +A1(2008) +A2(2010) RF-field immunity EN 60335-1 (2012)/AC:2014 Safety – Part 1: General requirements
Directive – Low Voltage Directive LVD 2014/35/EU	EN 60335-1 (2012)/AC:2014 Safety of household and similar electrical appliance/Part 1. EN 60335-2-103:2015
TÜV type examination	EN 12453 (2017) Industrial, commercial and garage doors and gates. Safety in use. EN ISO 13849-1:2015 Safety of machinery

43. Declaration of Conformity

CE Declaration – Control Unit



Declaration under sole responsibility that the door control units:

Mini Std. V7E SR

and technical documentation manufactured at:

Dalmatic TNV A/S
LÆGÅRDSVEJ 9
8520 Lystrup DK

are in accordance with the following Directives:

EMC Directive (Directive 2014/30/EU) relating to electromagnetic compatibility.
Machinery Directive 2006/42/EC
Low Voltage Directive 2014/35/EU) to electrical equipment intended for use within certain voltage limits.

Furthermore, it is declared that the following standards have been used:

EN 60335-1:2012/ AC:2014	Household and similar electrical appliances – Safety
EN 60335-2-103:2015	Household and similar electrical appliances – Safety – Particular requirements for drives for gates, doors and windows
EN 61000-6-2:2005	EMC – Immunity for industrial environments)
EN 61000-6-3:2007 +A1:2011	EMC – Emission standard for residential, commercial and light industrial environments)
EN12453:2017	Industrial, commercial and garage doors and gates Safety in use of power operated doors, gates & traffic barriers.
EN ISO 13849-1:2015	Safety of machinery.
EN 12978:2003 A1: 2009	Industrial, commercial and garage doors and gates Safety devices for power operated doors and gates.

Responsible for technical documentation

EC type examination
No.: 44 205 18194901
TüV Nord Cert GmbH
Langemarkstrasse 20
45141 Essen

© - Lystrup | 10.10.2018

Hans Hilmar Dall, Owner and director

CE Declaration – Gear Motor

Machinery Directive, 2006/42/EC, Annex II, para. B (Component Declaration) Prohibition of deployment

Declaration under sole responsibility that the gear motors:

PRO-LINE 70

manufactured at:

ConDoor Door Solutions
3899 AA Zeewolde NL

- are meant to be incorporated into machinery or assembled with other parts of the machinery for deployment as machines covered by the Machinery Directive 2006/42/EC as amended, and with national legislation transposing this Directive (Labor Inspectorate order 561/94).
- therefore do not fulfill this Directive fully.
- are in accordance with the instructions of the following directives: LVD 2006/95/EG, EMV 2004/108/EG, RoHS 2002/95/EG & 2002/96/EG.

Furthermore, it is declared that the following harmonized standards have been observed:

EN 60034-1
EN 60034 -5
EN 60034-7
EN 60034-9
EN 60034-14
EN 60034-8
EN 60072-1

Furthermore, the declared prohibition of deployment until the machine in which it will be assembled as a whole, including the machine components that are referenced in this declaration, has been declared in accordance with all relevant provisions of the Machinery Directive 2006/95/EC

Responsible for technical documentation

Zeewolde, 14.8.2019



Jaap Kwant, Managing Director

